

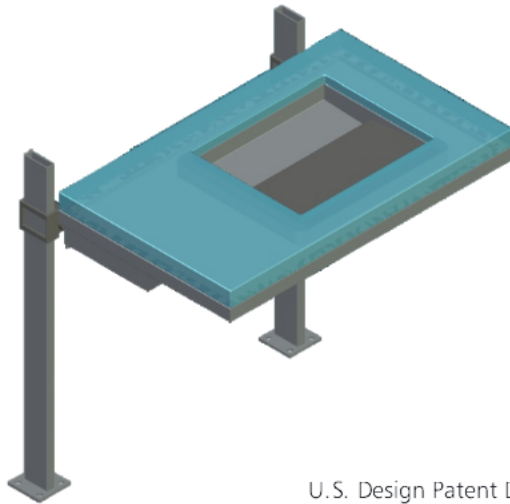





36" Ebb® Concept Wall Mounted

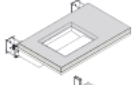

U.S. Design Patent D560,783

Model Shown: 9110-WM-MC-FLR-S-RDC05-3763-RH-NFD
 36" Ebb Concept Wall Mounted Deck, Commercial Floor Mounted Arm/Carrier, Satin Finish Frame, Skye Resin, Satin Finish 19" Long Shallow Right Configured Ebb Basin; No Faucet Drilling

- **WALL MOUNTED 36" CAST RESIN DECK MADE EXCLUSIVELY FOR NEO-METRO'S EBB (HIDDEN DRAIN STAINLESS STEEL) BASIN**
- **Stainless Steel Frame Construction Satin Finish is Standard. Optional Finishes include Mira (High Polish), White Gloss Powdercoat and Black Matte Powdercoat**
- **Colored Resin Deck- Various colors available; Custom color can be specified**
- **Deck in White Solid Surface also Available**
- **Residential/Light Commercial Mounting Carrier is Supplied (Heavy-Duty Commercial Floor Mounted Carrier is also Available)**
- **Meets ADA Compliancy when 3673 Ebb Basin is Used (See Faucet Compliancy)** 
- **Left, Right or Centered Ebb Basin Placement in Deck**
- **Attractive Under Counter LED Lighting is Available**
- **Neo-Metro Stainless Steel Faucets are Available**

DESCRIPTION	MODEL/OPTION #
A ORIENTATION - Required Selection	INIT. _____
<input type="checkbox"/> Wall Mounted Deck includes Wall Carrier - MC	9110-WM
 <input type="checkbox"/> Standard Arm/Wall Mounted Carrier Suggested for residential/light commercial applications	- MC 
 <input type="checkbox"/> Commercial Floor Mounted Arm/Carrier Required for commercial application (requires 2" x 6" wall construction)	- MC-FLR 
CONSTRUCTION INFORMATION Must Specify: Wall Thickness _____	
Must Specify: Wall Type _____ (Eg. drywall with tile, concrete, etc.)	
Add (+) B FRAME - Required Selection	INIT. _____
<input type="checkbox"/> Satin Finish (Standard)	- S
<input type="checkbox"/> Mira Finish (High Polish)	- HP
<input type="checkbox"/> White Gloss Powdercoat	- EG-10
<input type="checkbox"/> Black Matte Powdercoat	- EG-22
Add (+) C RESIN DECK MATERIAL - Required Selection	INIT. _____
Resin Deck Material	
<input type="checkbox"/> Cloud Nine Resin (white)	- RDC01
<input type="checkbox"/> Stealth Fog Resin (smoke/glossy)	- RDC02
<input type="checkbox"/> Yokan Resin (dark amber)	- RDC03
<input type="checkbox"/> Oceana Resin (light aqua)	- RDC04
<input type="checkbox"/> Skye Resin (dark blue)	- RDC05
<input type="checkbox"/> Cranjuice Resin (deep red)	- RDC06
<input type="checkbox"/> Wineberry Resin (purple)	- RDC07
<input type="checkbox"/> Green Tea (olive green)	- RDC08
<input type="checkbox"/> Green Apple Resin (yellow-green)	- RDC09
<input type="checkbox"/> Blanco Solid Surface (white/solid color)	- RDC10
<input type="checkbox"/> Tangerine Dream Resin (orange)	- RDC11
<input type="checkbox"/> Blueberry Resin (turquoise)	- RDC12
<input type="checkbox"/> Custom Color Resin	- RDC00
Specify Pantone® Color _____ or supply tile, color chip, sample	



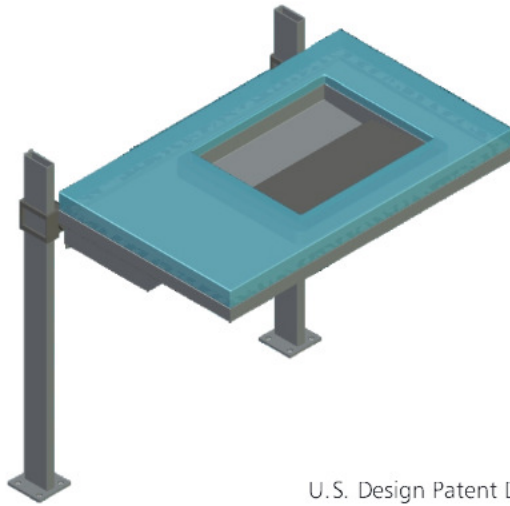

36" Ebb® Concept Wall Mounted





U.S. Design Patent D560,783

Model Shown: 9110-WM-MC-FLR-S-RDC05-3763-RH-LGT-FBO
 36" Ebb Concept Wall Mounted Deck, Commercial Floor Mounted Arm/Carrier, Satin Finish Frame, Skye Resin, Satin Finish 19" Long Shallow Right Hand Configured Ebb Basin, Undercounter LED Lighting System (110 V); Faucets Supplied by Customer

DESCRIPTION **MODEL/OPTION #**

Add (+)	D EBB BASIN SELECTION - Required Selection INIT. <input type="checkbox"/>	
	  	<p>Deep Ebb Basin</p> <p><input type="checkbox"/> Satin (standard) -3670 <input type="checkbox"/> Mira (high polish) -3670-HP <input type="checkbox"/> White Gloss Powdercoat -3670-EG-10</p> <p>Shallow Ebb Basin</p> <p><input type="checkbox"/> Satin (standard) -3673 <input type="checkbox"/> Mira (high polish) -3673-HP <input type="checkbox"/> White Gloss Powdercoat -3673-EG-10</p> <p>ADA Compliance: The 9110-WM Ebb Concept Wall Mounted is ADA Compliant when the Shallow Ebb Basin 3673 is used. Other ADA considerations may be required including faucet configurations (Neo-Metro has several ADA compliant solutions.) Additionally, please check your local ADA regulations.</p> <p>Option for Ebb Basin</p> <p><input type="checkbox"/> Overflow Waste Outlet - OF</p>

REQUIRED	Please indicate location of basin:		
	 <input type="checkbox"/> - LH Left Offset	 <input type="checkbox"/> - CTR Centered	 <input type="checkbox"/> - RH Right Offset

Add (+)	E UNDERCOUNTER LIGHTING INIT. <input type="checkbox"/>	
	This option is not available with -RDC10 (Blanco Deck)	
	<p><input type="checkbox"/> LED Lighting System (110 Volts) - LGT</p> <p><input type="checkbox"/> LED Lighting System (220 Volts) - LGT-220V</p>	

F FAUCET DRILLING CONFIGURATIONS NOTE: An undercounter light (-LGT) may need to be eliminated or relocated with a deck mounted faucet. INIT.

- Customer Supplies Own Faucet**
- Select as applicable:**
- FBO **Faucet by Others** - Customer will supply own faucet(s). Custom Faucet Drilling Template (see separate sheet) must be submitted indicating where the resin deck needs to be drilled for faucets (including spout/control handles).
 - NFD **No Faucet Drilling** - Customer will supply own faucet however, spout and control handle(s) will both be wall mounted.
- Select one:**
- Standard Drilling for Deck with - LH Basin Offset (As shown on larger image)
 - Standard Drilling for Deck with - RH Basin Offset (The control handle positions are mirrored as show in inset)
 - Custom Drilling (See separate Custom Mounting Template)

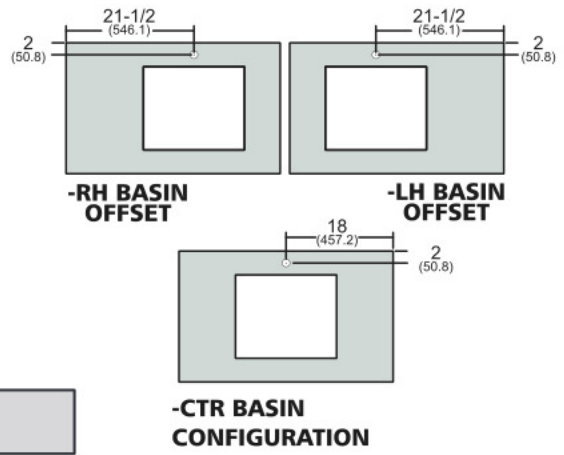

Neo-Metro assumes no responsibility for use of void or suspended data. All dimensions are nominal and subject to manufacturer change without notice.

Orders will not be processed until specification sheets including faucet drilling worksheets are complete and signed. No cancellations.

36" Ebb Concept Wall Mounted

How to Assemble a Ebb Concept Model Number



9110-WM -

Wall Carrier/Arm - MC (Standard) - MC-FLR (Commercial)	Frame Finish - S (Satin) - HP (Mira) - EG-10 (White) - EG-22 (Black)	Deck Material (Resin) - RDC01 (Cloud Nine) - RDC02 (Stealth Fog) - RDC03 (Yokan) - RDC04 (Oceana) - RDC05 (Skye) - RDC06 (Cranjuice) - RDC07 (Wineberry) - RDC09 (Green Apple) - RDC11 (Tangerine Dream) - RDC12 (Blueberry) - RDC13 (Canary) - RDC00 (Custom) - RDC10 (Blanco Solid Surface) - OCT02 (Midnight Rose Terrazzo)	Ebb Basin - 3670 (Deep) - 3673 (Shallow)	Basin Finish - S (Satin) - HP (Mira) - EG-10 (White) - EG-22 (Black)	Other Basin Options - OF - FIB <small>Skip if not ordering, may order one or both</small>	(Basin) Offset - LH (left) - RH (right) - CTR (center)	Under-counter Lighting - LGT - LGT-220V <small>Skip if not ordering Not available with -RDC10 or with -OCT02.</small>	Faucet - FBO - NFD
---	---	---	---	---	---	--	---	---------------------------------

Example:

9110-WM - MC - EG-10 - RDC05 - 3673 - EG-10 - LGT - NMF-2

Standard Arm	White Gloss Powdercoat	Skye (Blue) Resin	Shallow 17" Long Ebb Basin	White Gloss Powdercoat	Left Hand Offset	LED Lighting System (110 V)	Satin Finish Deck Mounted Faucet with Spout & Dual Control.
--------------	------------------------	-------------------	----------------------------	------------------------	------------------	-----------------------------	---

Now it's your turn! Please fill in blanks provided on the top line to assemble the model number corresponding to the features you want on your Ebb Concept.

COLOR RESIN DISCLAIMER

Please be aware that Neo-Metro makes every attempt to achieve color correctness. Neo-Metro does build the Ebb Concept with the assumption that the color will match when the customer uses either the Neo-Metro lighting system or some other lighting system provided by the client. If your Ebb Concept will be used with out the lights, you need to notify Neo-Metro prior to manufacturing due to the fact the resin will appear to have different colors.

Orders will not be processed until specification sheets including faucet drilling worksheets are complete and signed. NO CANCELLATIONS.

COMPANY: _____
 PROJECT NAME: _____
 SIGNEE'S NAME WRITTEN CLEARLY: _____ DATE: _____
 AUTHORIZED SIGNATURE: _____

